

KEYSTONE **COUNTRY MANOR[®] SYSTEM** DESIGN & CONSTRUCTION



KEYSTONE[®]
Country Manor

Stonegate



Charming Versatility

Successful designers and contractors across the globe favor the appeal and design flexibility of the Keystone Country Manor wall system. Want to set your project apart? Utilize the Keystone Country Manor wall system to create signature structures, from retaining walls to dream outdoor living spaces.

The Keystone Country Manor wall system features face options to best match the personality of the project. The original Country Manor units have a weathered or antique finish. The Stonegate units offer a smooth face with a more refined appearance. As the unit sizes for each face option are identical, the design features, details, outdoor living environments and design charts contained within this manual can be used with Country Manor or Stonegate units.



Stonegate®

Table of Contents

The Product.....	4
Features.....	5
Outdoor Living Environments	6
Wall Installation.....	8
Design Details	
Corners	10
Curves.....	11
Step Designs	12
Capping/Coping Options.....	13
Unit Dimension Combinations	13
Vertical Unit Orientation.....	13
Freestanding Walls	14
Columns	15
Wall Offset.....	16
L-Return End	16
Pilaster Detail	17
Terraces	17
Design Considerations.....	18
Design Charts.....	19
Get Inspired!.....	22

Unmatched Flexibility

Positive Mechanical Connection with
Keystone Pins

Vertical, Battered and
Parapet Options

Simplicity of Construction

Wall Solutions from Gravity
to Soil-Reinforced

Freestanding Walls and Outdoor Living
Elements such as Fireplaces, Kitchens,
Fire Pits, Benches and More...



Country Manor®

The Product

In addition to providing strength and beauty, these units can create signature hardscape designs that set your project apart from all others. The ability to create freestanding walls allows for the creation of barbecues and outdoor kitchens, bench seating and the concealment of outdoor lighting and speaker systems. Use the Keystone Country Manor wall system to provide detail and accent to a large lawn or green space, add grandeur to a drive or walkway, or create a truly unique pool/patio area.

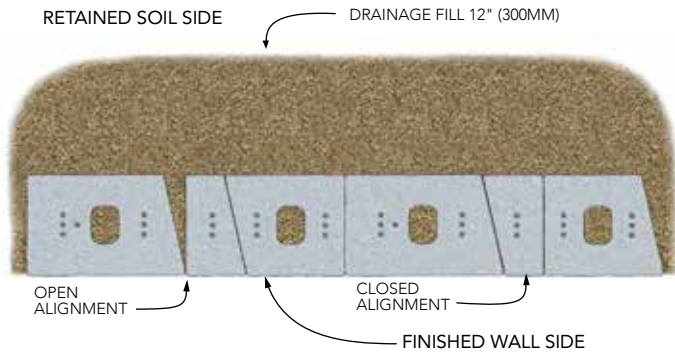

Product Specifications

	HEIGHT	WIDTH	DEPTH	WEIGHT
6" Large	6" (152mm)	16"/14" (406mm/356mm)	10" (254mm)	60-65 lbs (27-29 kg)
6" Medium	6" (152mm)	12"/10" (305mm/254mm)	10" (254mm)	47-51 lbs (20-23 kg)
6" Small	6" (152mm)	6"/4" (152mm/102mm)	10" (254mm)	21-24 lbs (10-11 kg)
3" Large	3" (76mm)	16"/14" (406mm/356mm)	10" (254mm)	30-33 lbs (14-15 kg)
3" Medium	3" (76mm)	12"/10" (305mm/254mm)	10" (254mm)	22-24 lbs (10-11 kg)
3" Small	3" (76mm)	6"/4" (152mm/102mm)	10" (254mm)	9-11 lbs (4-5 kg)
Cap Option 1	3" (76mm)	14"/8" (356mm/203mm)	12" (305mm)	27-31 lbs (12-14 kg)
Cap Option 2	3" (76mm)	12"/10" (305mm/254mm)	11" (279mm)	27-30 lbs (12-14 kg)



Country Manor®

The rustic charm of hand-laid stone with textured tumbled units.



Country Manor is available as a 2-pc system (large & small unit) in some markets. Contact your local distributor for product availability in your area.

Stonegate®

Smooth, weathered, tumbled appearance for a refined look.



Stonegate® - Contemporary

Clean, non-tumbled lines provide a contemporary appeal.



3" Stonegate® / Country Manor®

Use alone or combine with 6" units for an ashlar appearance.





Stonegate® - Contemporary

Each unit has three finished sides. The third finished side is created by the closed end of the receiving channel at the bottom of each unit which allows for finished end aesthetics on 90° corners, pilasters and wall end conditions. At times, a pin from a unit below may interfere with the closed channel. To clear this interference, the upper unit may be rotated 180° or the pin may be removed.



The receiving channel on the bottom surface of each unit connects over the pins from the course below. With the structural pin connection, walls can be built in 90° corners, curves and straight wall geometry without loss of connection strength or unit stability.

Pins

Keystone's shouldered pin is made from high strength pultruded fiberglass. The plastic alignment pin utilizes a unique friction fin design and is intended for use in gravity walls up to 3' (1m) high.



Specifications	Shouldered Pin	Alignment Pin
Total Length	3¾" (95mm)	1½" (60mm)
Pin Diameter	½" (13mm)	½" (13mm)
Shoulder Diameter	¾" (19mm)	¾" (19mm)
Shoulder Length	⅞" (22mm)	½" (13mm)

Cap Size Options



Cap Option 1



Cap Option 2

Features

Three or More Face Dimensions

- Provides the greatest degree of random layout due to variations from unit side dimensions.
- Each unit has two side dimensions to provide random width appearance to the wall.

Colors

- Produced in color blends that enhance the natural stone-like appearance.

Three Textured Sides on Each Unit

- Each unit can be used as an exposed end unit or a 90° corner unit.
- Allows each unit to be used in multiple positions within the wall.
- Allows construction of small freestanding walls, parapet walls, pilasters and columns in addition to retaining walls, without the need to field cut any units.

Shape

- Each unit has a 90° angle and a tapered (angled) side, allowing the units to be used in 90° corners, tight-fitting straight line walls, and radii at curves.

Packaging

- 3-piece systems are packaged in sets, eliminating the need for the contractor to pull from multiple pallets to maintain a random appearance.
- 2-piece Country Manor system is palletized by unit.

High Strength Pins

- Multiple pin positions allow for near vertical, 9.5° batter (1° positive setback for retaining walls), and the opportunity to randomly pull a unit forward to accent the wall.



Stonegate® - 3" and 6" Combined

Outdoor Living Environments

With the Keystone Country Manor wall system, outdoor living options are almost endless. Providing unsurpassed design flexibility, outdoor living environments can be built all at once, or as time and budget allow. Use one or multiple step-by-step projects to take an outdoor space from ordinary to extraordinary.



Stonegate®

Fire Pits & Fireplaces



Stonegate®



Country Manor®



Columns



Benches



Mailboxes



Outdoor Kitchens



Visit our website for a variety of step-by-step outdoor living designs: www.keystonewalls.com.



Wall Installation

Pattern & Appearance

“Rule of Thumb” for bond pattern between courses: construct the wall using the units as they come off each shipping pallet. Randomly utilize the various unit shapes, trying to avoid a repetition of same unit size frequency along a horizontal line (some unit repetition is unavoidable). *Avoid stack bonding of unit joints (vertical joint line between adjoining units) for more than two courses vertically.* If some units seem to have a blemish or too much texturing in a specific area, orient them so the blemish faces the soil side of the wall to hide imperfections or use these units along the wall base.

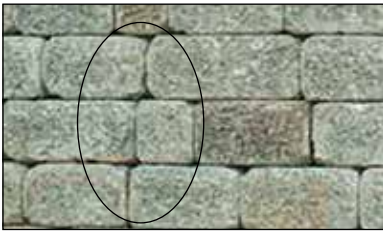

Avoid “stack bond” conditions where more than two courses create weak areas in the wall.

Embedment

Unit embedment below the grade line shall be a minimum of one unit buried, under all conditions, along with a general provision of $H/20$ (wall height divided by 20) for total wall embedment of taller walls. Note H =total height of wall from top of base leveling pad to top of wall. Consult a qualified engineer for sloping grade conditions in front of wall or steep slopes and surcharge loads on top of wall. Deeper embedment may be required in areas prone to surface scouring where base erosion is possible, or in areas where freestanding walls are desired and frost depths require deeper foundations.

1. PREPARE BASE LEVELING PAD



Remove all surface vegetation and debris. Do not use this material as backfill. After selecting the location and length of the wall, excavate the base trench to the designed width and depth (min. 20" w x 12" d [508mm x 305mm]). Start the leveling pad at the lowest elevation along wall alignment. Step up in 6" (152mm) increments with the base as required at elevation changes in the foundation. Level the prepared base with 6" (152mm) of well-compacted granular fill (gravel, road base, or 1/2" to 3/4" [13mm - 19 mm] crushed stone). Compact to 95% Standard Proctor or greater. Do not use PEA GRAVEL or SAND for leveling pad.

2. INSTALL THE BASE COURSE



Place the first course of units end to end (with front corners touching) on the prepared base. The long groove (receiving channel) on the unit should be placed down and the three pin holes should face up, as shown. Make sure each unit is level - side to side and front to back. Leveling the first course is critical for accurate and acceptable results. For alignment of straight walls, use a string line aligned on the unit pin holes for accuracy. Minimum embedment of base course is 6" (152mm) below grade.

3. INSERT THE PINS



Place the pins into the holes of the units (note: place one pin only per each grouping of three holes). Place pins in the middle hole for near vertical alignment or the holes nearest the embankment for a 9.5" +/- setback per course. According to wall requirements and design, the front pin hole (towards the face of the wall) can be used randomly to allow a forward projection of a specific unit for accent and variation in the wall appearance.

4. INSTALL FILL & COMPACTION



Once the pins have been installed, provide 1/2" - 3/4" (13mm - 19mm) crushed stone drainage fill behind the units to a minimum depth of 12" (305mm). Fill open spaces between units and open cavities/cores with the same drainage material. Proceed to place backfill in **MAXIMUM 6"** (152mm) layers (lifts) and compact to 95% Standard Proctor with the appropriate compaction equipment. Do not use heavy ride-on compaction equipment within 3' (1m) from back of wall. Do not use jumping or ramming type compaction.

5. INSTALL ADDITIONAL COURSES



Place the next course of units over the pins, fitting the pins into the long receiving channel recess of the units above. Note: some removal of debris in the pin holes and channel may be necessary prior to placement. Push the units toward the face of the wall until they make full contact with the pins. If pins do not connect with channel but align in open core of upper unit, place drainage fill in core to provide unit interlock with pin. For near vertical alignment, center the unit above over the center-placed pins below.

6. CAPPING THE WALL



Continue all steps until ready to place the wall cap. Clean off the last course of unit in preparation for the cap or coping to finalize the wall. With units dry and clean, use exterior grade construction adhesive to secure the caps to the units. Install the 3" (76mm) capping unit, architectural precast concrete or cut stone as a coping element. Cap may be flush or overhanging as required by aesthetics and design. Note: for taller, more critical walls, refer to geogrid soil reinforcement instructions on the following page.

Geogrid Soil Reinforcement

Taller walls, or walls supporting surcharge loads, require the use of geogrid reinforcement material to reinforce a soil mass directly behind the retaining wall and provide connection to the concrete facing units.

Geogrid properties and wall design require knowledge of wall heights, soil properties (Phi angle and moist unit weight), surcharge loads and manufacturer's requirements for specific geogrid types and strength capabilities.

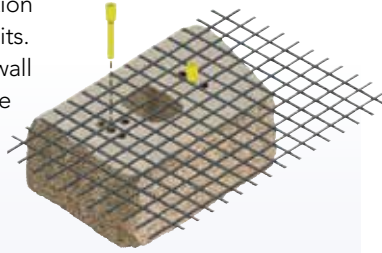

See the Design Charts in the back of this manual for assistance in determining the lengths and placement locations. A qualified professional should be consulted for final design assistance.

Excavate Reinforced Soil Area: Remove existing soil in the reinforced soil zone to the maximum embedment length of the geogrid design. Level and compact soil behind the wall prior to placement of each geogrid layer.

Cut Geogrid: Cut sections from the geogrid roll to the specified length (embedment length). Check manufacturer's criteria for biaxial or uniaxial geogrids. In most cases, the correct orientation is to roll the geogrid perpendicular to the wall face.

Install Geogrid: Place geogrid over the Keystone shouldered pins already in place. Note: allow approximately 3" (76mm) of geogrid material to rest on the unit top surface ahead of the pin (from pin to face of wall). This will ensure that the next course above will be fully supported on geogrid. Place all sections of geogrid, abutting each other side-to-side as per manufacturers' instructions.

Secure Geogrid: Pull the pinned geogrid taut to eliminate loose folds. Stake or secure the back edge of geogrid before backfill and compaction. Compact from back of wall area toward embankment to avoid loosening geogrid or putting compaction pressure on wall. Remove stakes, as required, once backfill is placed.

Install next course of wall units.

Follow steps 3-5 (on page 8) until next geogrid layer or completion of wall.

Stepped Footing (Leveling Pad)

Leveling pad options:

- Compacted free-draining granular fill (inorganic)
- Crushed stone road base
- $\frac{3}{8}$ " - $\frac{3}{4}$ " (10mm - 19mm) crushed stone
- Non-reinforced concrete (2,000 psi)

Leveling pad thickness:

- 6" (152mm) \pm granular materials
- 3" (76mm) \pm concrete option

Always start wall at lowest elevation of site location where wall is to be constructed. Build step-ups in leveling pad to match 6" (152mm) unit thickness. When using non-reinforced concrete for the leveling pad option, it is critical that the step-ups exactly match the unit thickness. With a concrete leveling pad, there are few options for correction if the step-up is built higher than the unit height.

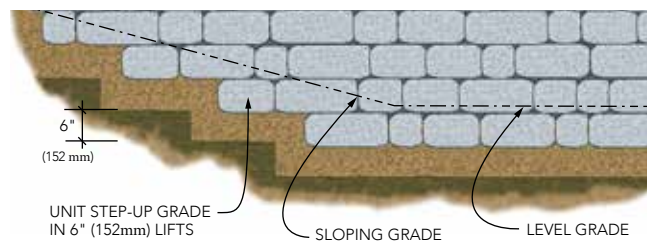

NOTE: MAINTAIN A MINIMUM ONE UNIT OF BASE COURSE BURIED

General Notes

- Units may vary due to texturing processes and unit sizes by region. Verify unit type, size, weight availability by region. Units may vary up to 1" (25mm) \pm due to texture variations.
- Clean out pin holes and receiving channel as required to assemble wall. During manufacturing, some concrete crumbs may deposit in these areas and should be removed to permit pins to be placed in the appropriate holes and receiving channel.
- Cut or split units as required (with a mason saw, hydraulic break or chisel and hammer) for corners, caps or wherever units need to be altered to allow construction to be finalized. (Cuts produce smooth finish; splits produce textured finish.)
- When cutting concrete units, always wear safety goggles, gloves and filter mask per manufacturer's recommendations.
- Use exterior grade construction adhesive for all units in parapet walls, columns, etc. where wall is built freestanding (not retaining soil). Use vertical bead of adhesive between units in freestanding wall to avoid daylight view through wall units. Use adhesive as required at 90° corners or where pins do not interconnect units.



Country Manor®

Design Details

Corners

With the Keystone Country Manor wall system, corners are a natural part of your creative design. All units are capable of being used in a 90° corner due to having one end square and three sides textured. This allows units to build retaining and freestanding structures with one, two, or three faces exposed. For taller walls, it is recommended that the "Large Unit" be used at corners to achieve greater strength through overlap and interlock with units above and below.

The large unit has an extra pin position for connection to the next course above in a 90° corner which runs in a perpendicular orientation.

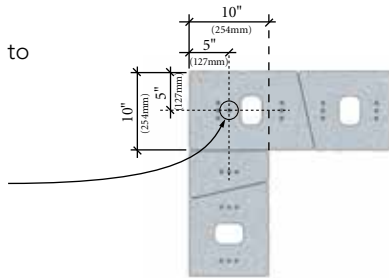

90° Corners

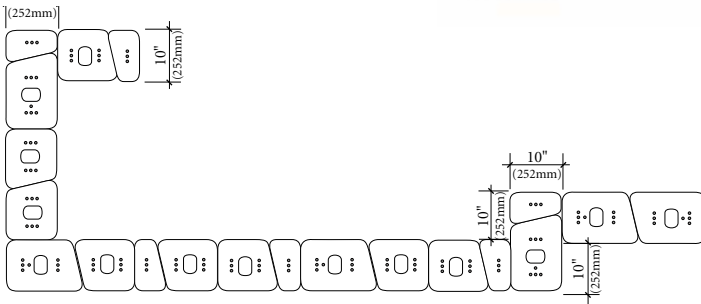

Stonegate® - Contemporary

Near Vertical Corners

All units have one square end and an angled end. Use the square end of any unit to create the corner condition on an inside or outside corner. It is beneficial to use the largest unit for construction of the corner for strength.

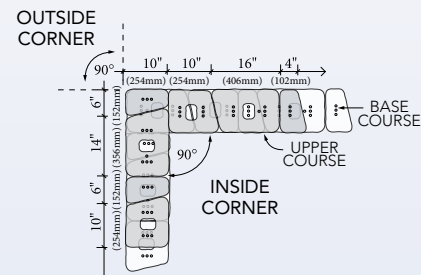
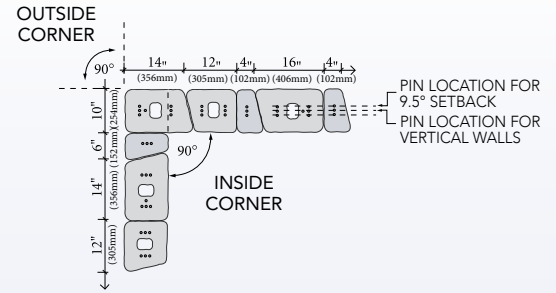

Corners With Setback

Corners with a positive setback build in a similar random course pattern to the near vertical corner. In the setback version, each course of pins is set in the 1" (25mm) offset position. Units shift laterally as required to achieve the 1" (25mm) setback.

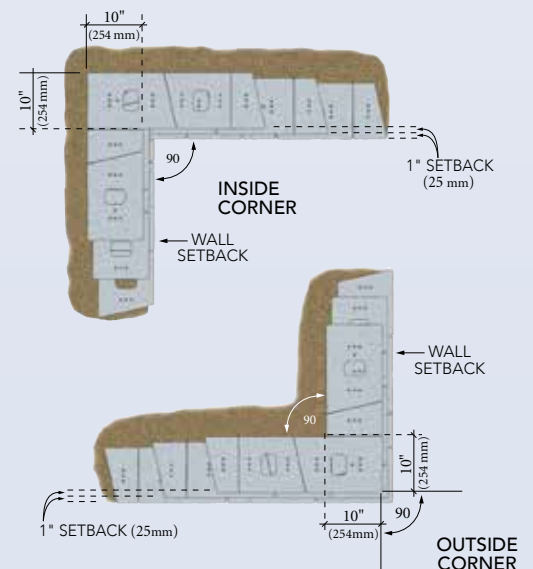

Retaining wall curves can be built in both convex (outward) and concave (inward) layouts using the “near vertical” or 1” (25mm) setback options. For freestanding walls (above grade), always build in the vertical position.



Curves

The unit design makes it easy to construct a variety of serpentine curves. Convex and concave curves will add gentle grace, beauty and strength to any installation.

Retaining Walls: Place the units to follow the desired curve. If unit-to-unit geometry creates small V-shaped voids on the retained soil side, just fill these areas with drainage fill.

Parapet Walls: When units are exposed on two sides, select the proper unit layout that provides tight closed-end conditions for all units to avoid a gapped look on either side of the parapet. Cutting of units may be required to avoid gaps in freestanding walls.

Radius: The minimum radius that can be built using the random pattern of units without cutting or using a disproportionate amount of the smaller units is 4.5' (1.4m). To build smaller radii, a larger proportion of small units and some cutting may be required.

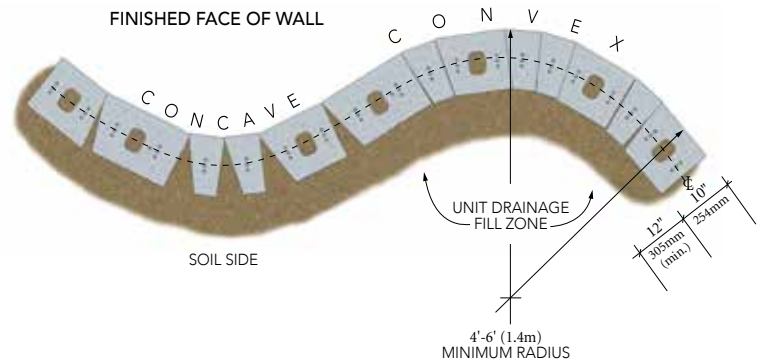

Country Manor®



Provide handrail/railing/fence as per local building code. The railing/fence posts should be grouted into sleeves placed within the wall backfill during construction. Consult Keystone or a local engineer for guidance.

Design Details

Step Designs

The Keystone Country Manor wall system can be used on your step/stair projects with the following considerations:

- Provide the same material at the step foundation as used on the wall leveling pad.
- Compact leveling pad material to a minimum 95% Standard Proctor. Note: adding cement can provide the additional benefit of firming up this area in a cemented soil composite.
- Double stack the base support units to create a foundation for the stair "tread" units. Use pins and construction adhesive as required for a unified step assembly.

Note: A cemented soil composite can help shape the step/stair foundation and eliminate the need to double stack the "tread" units.

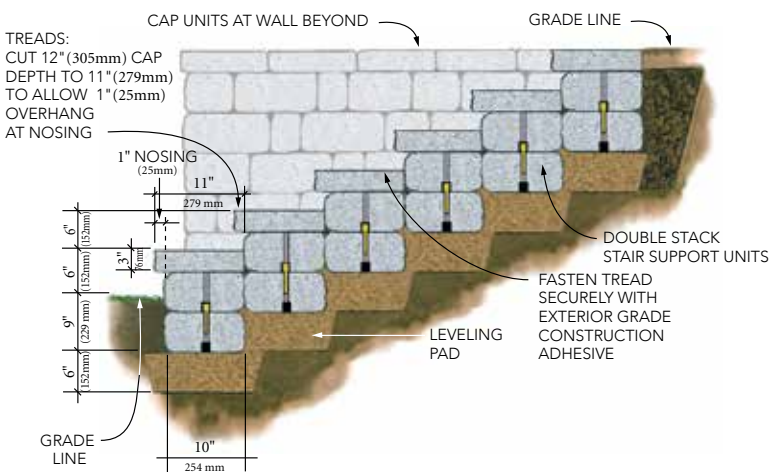

Capping / Coping Options

The 3" (76mm) high cap unit has two textured sides allowing the unit to have either textured side as a finished face for straight and curved wall applications. The 12" (305mm) depth from face to face of the cap allows for a 1" (25mm) overhang or "shadow" effect over each side of the wall below. For retaining walls, the overhang can be eliminated if desired by pushing the cap back flush with wall plane. Use exterior grade construction adhesive to fasten caps in place.

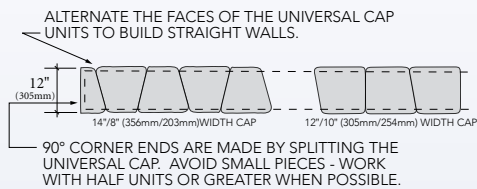

The two parallel faces of the universal cap unit are textured such that either side can be the finished face.

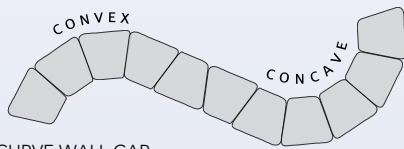

CURVE WALL CAP

Small gaps between cap units or some cutting may be required to achieve specific cap course radii.



Country Manor®

Unit Dimension Combinations

When developing the wall design and layout for straight or curved walls with corners, offsets, pilasters, etc., use the following guidelines. Due to all units being 10" (254mm) deep (between parallel faces), it is best to work in increments of 10" (254mm) for geometry offset. In reviewing the design details in this brochure, note that all geometry offsets are measurements of 10" (254mm), 20" (508mm), 30" (762mm), etc. For running walls, either straight or curved, work in even dimensional increments for single units or combination of units as shown below. Build walls in random layout, adjusting with unit selection or unit cutting as required to fit between fixed dimension points.

Note: Some manufacturers offer different unit sizes which yield greater dimensional variation and layout options. Consult with your local manufacturer/distributor for additional information.

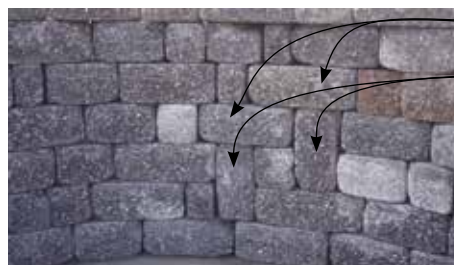
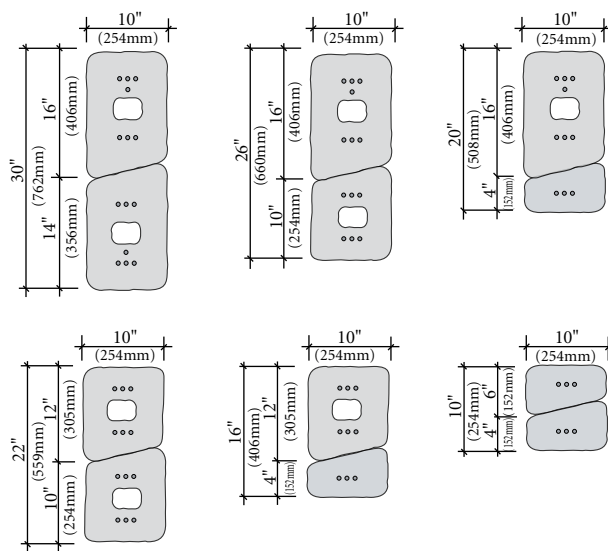

UNIT ABOVE VERTICAL UNIT SPANS TO BEAR ON EACH SIDE.
VERTICAL UNITS - 6" x 12" (152mm x 305mm)

Vertical Unit Orientation

A creative design option is to occasionally place units vertically in the wall to provide a break of horizontal lines. To span two 6" (152mm) high courses, use the unit with the 12" (305mm) length. The pins will not interlock in this position, so use exterior grade construction adhesive to fasten this unit in place. Make sure the unit above the 12" (305mm) vertical piece spans over or beyond the 6" (152mm) width of the vertical unit, resting on the units at each side.

Design Details

Freestanding Wall Applications

When considering freestanding wall conditions of any height, the designer must consider the requirements of geometry and internal reinforcing to resist overturning and seismic forces (where applicable). Reinforced footings/foundation depth must be considered to provide support and bearing as applied to soil and frost conditions. Due to the variable nature of each site situation, a qualified engineer should be consulted for appropriate design in accordance with local building codes.

The design details shown on the next few pages are for concept representation only and are not intended to represent final design. Consult a qualified engineer for specific design considerations.

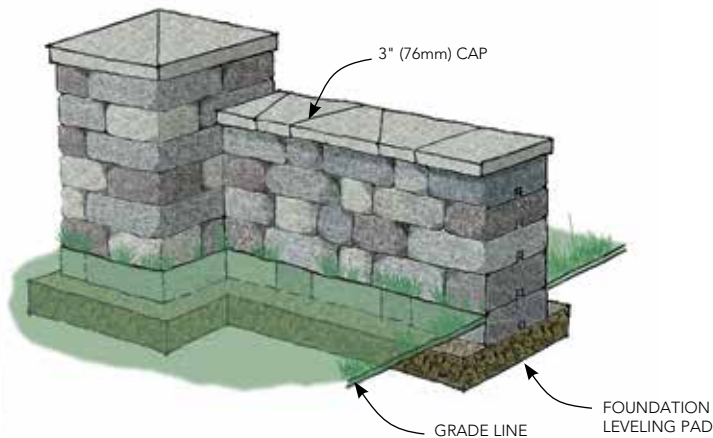

Freestanding Border Wall

With the Keystone Country Manor wall system, you have the added option of building unreinforced freestanding walls to various plan geometry and limited heights. From low border walls, which define the edge of patios and decks, to freestanding entry monuments, pilasters and parapets walls these units use interlocking geometry to achieve wider wall areas which provide strength and resistance to overturning forces.

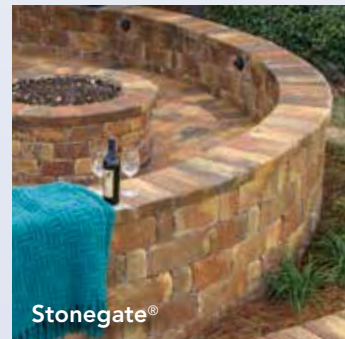
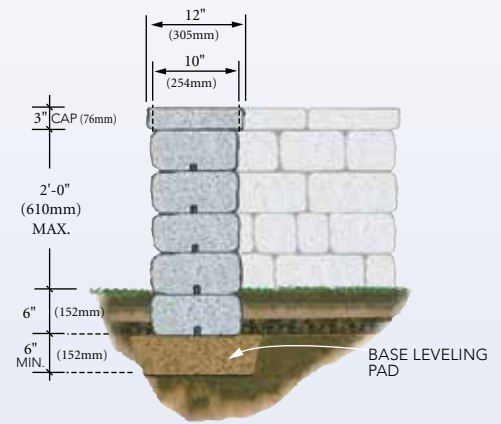

Wall End Column

The wall end column is a larger version of the "Column Corner" detail. The benefit of this design option is the development of internal reinforcement to provide for greater strength and height, along with a larger footprint dimension for aesthetic purposes.

INTERNAL COLUMN REINFORCING SHOULD PROVIDE FOR STEEL REBAR AND SOLID CONCRETE GROUTING IN CONNECTION WITH A REINFORCED CONCRETE FOUNDATION.

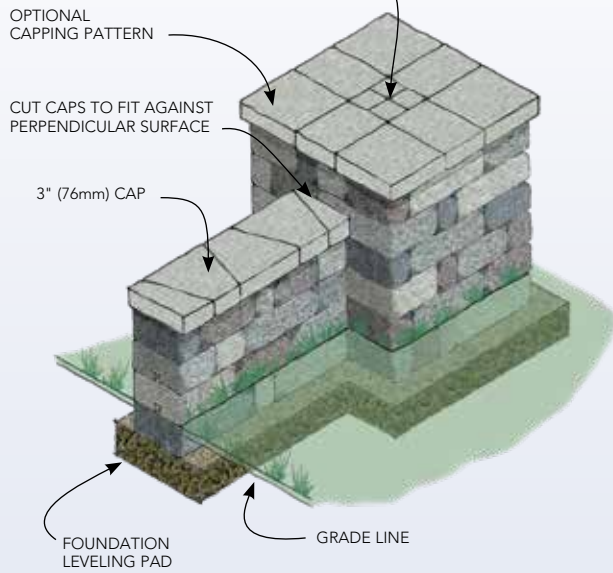

Column Corner

A typical column corner utilizes a 20" x 20" (508mm x 508mm) column geometry to develop an integrated pier at the end of a running wall. This detail offers visual aesthetic interest and provides strength at the end of the freestanding wall.

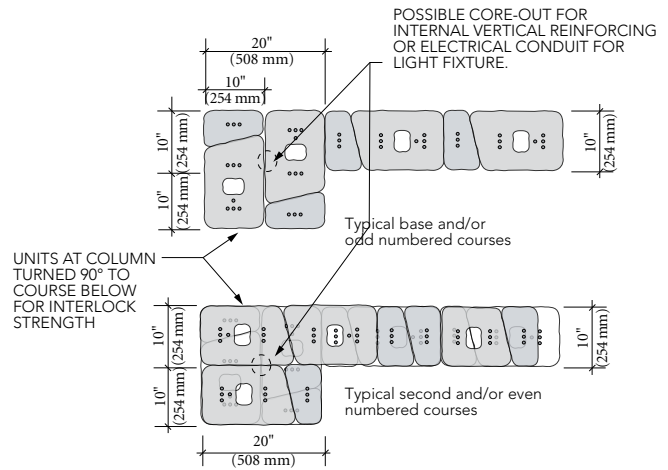
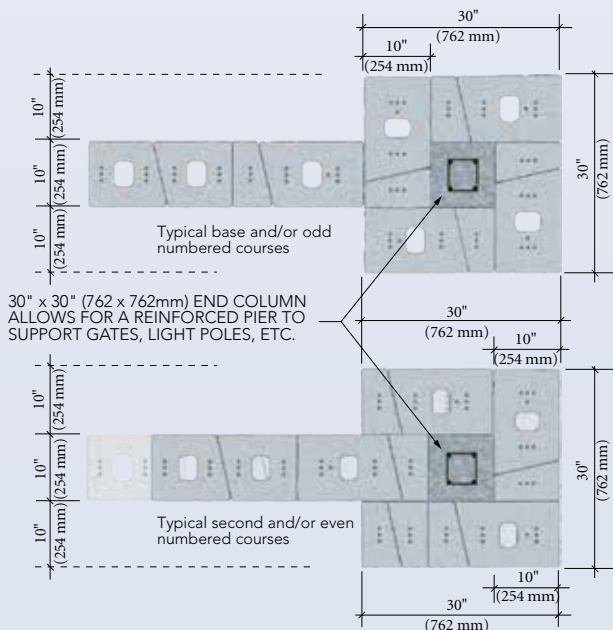

Column Top Options:

- Landscape lighting/entry
- Planter with flowers or ornamentals
- Yard figurine/sculpture
- Mailbox
- Street address monument

Design Details

Wall Offset

- Wider wall geometry (footprint) provides greater strength for parapet walls, to resist overturning.
- Offsets allow for graceful changes in wall direction.
- Offsets are an opportunity for aesthetic geometry and landscape feature areas.

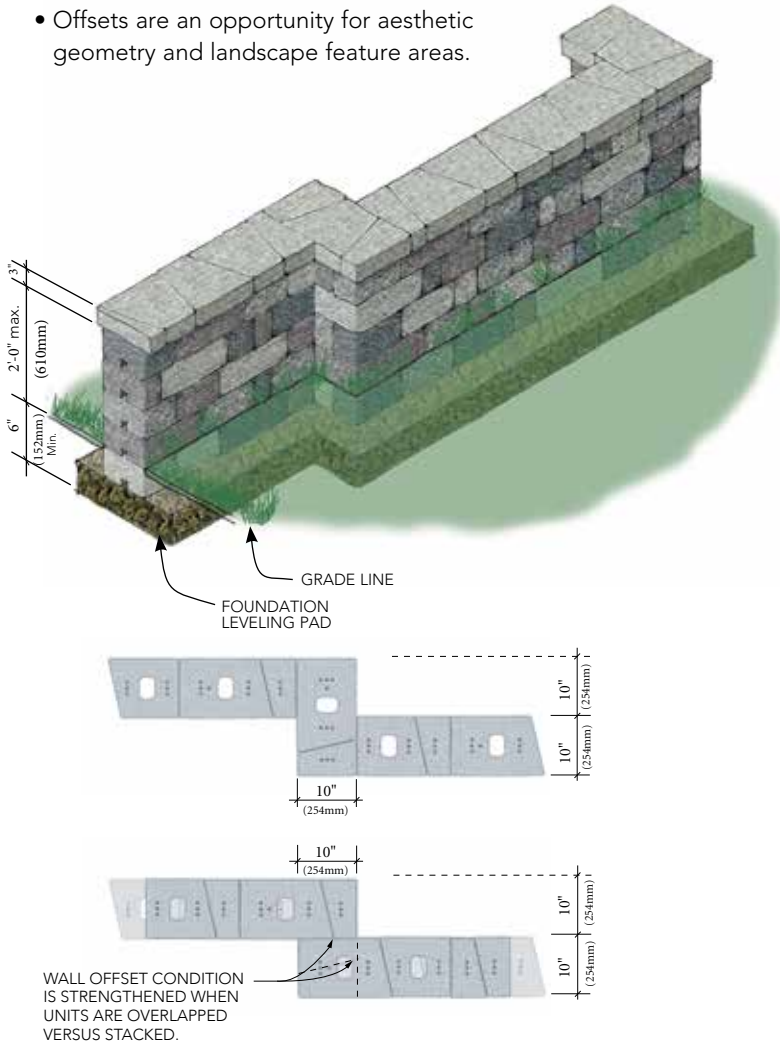

Notes:

- The minimum offset for two parallel walls as shown in the details on this page, is 10" (254mm). Continuous offsets @ maximum 10'-0" (3m) O.C. will provide strength at parapet walls in coordination with exterior grade construction adhesive and/or vertical reinforcement as required by engineer.
- It is important to use overlapping unit combinations at the offset location where two units combined together equal 20" (508mm) in length (see plan geometry above).
- Details showing freestanding wall applications are showing partial sections of walls. The unfinished ends, with channel openings visible, are not meant to portray a finished condition.



"L" Return End

Similar to column corners, this detail offers stability and strength to resist overturning forces at the end of a freestanding wall.

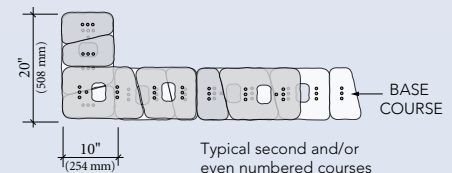
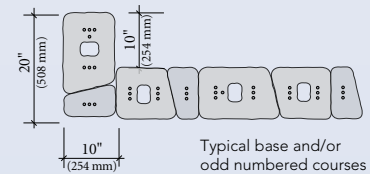
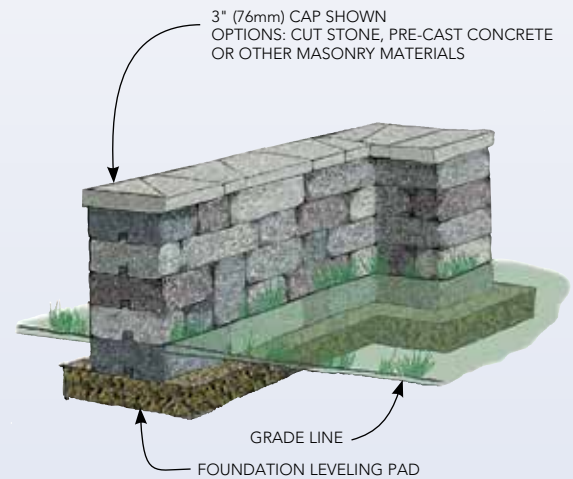



Terraces

Terraces are a visually pleasing way to build a taller retaining wall when aesthetics dictate the separation of walls to reduce the wall height and large mass appearance. Closely spaced terraces need to be reviewed by a qualified engineer to avoid global instability issues and to make sure soil reinforcement (geogrids) are properly designed to handle the loads for the entire wall structure. Terraced walls should be analyzed as a complete wall system versus individual walls unless they are spread apart greater than twice the wall height of each terrace and the soils are free-draining and granular in nature.

Pilaster Detail

The pilaster detail creates a deeper wall section within the wall which can provide stability for a retaining structure, freestanding wall or parapet.

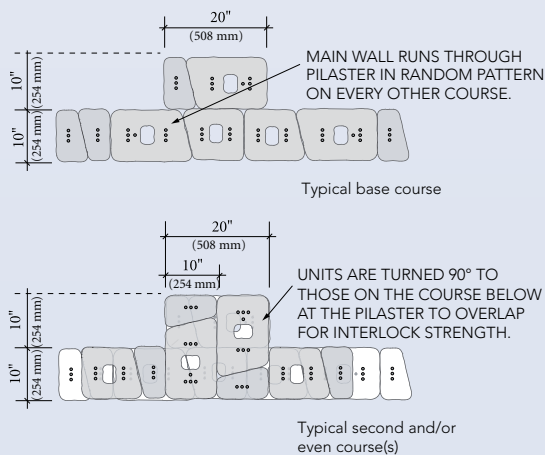
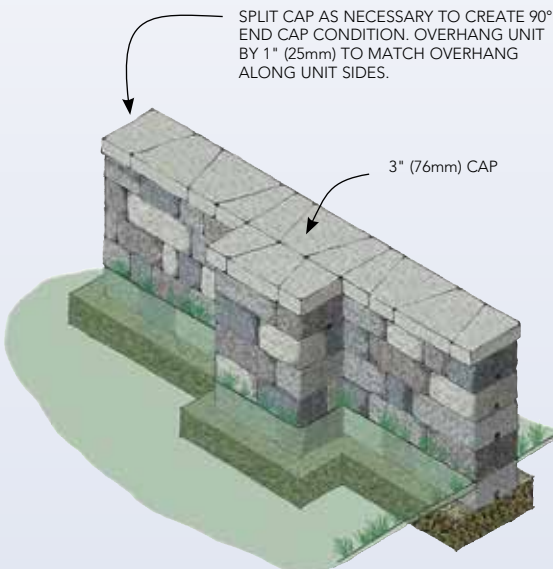

Terrace Wall Proximity Evaluation

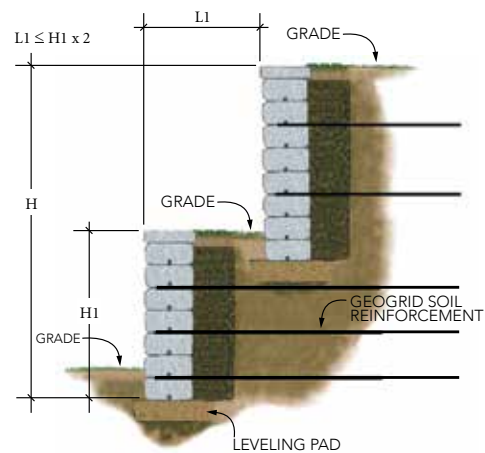

For walls where $L1 \leq H1 \times 2$, then the walls are to be considered as a composite and the entire wall height (H) needs to be considered in the design.

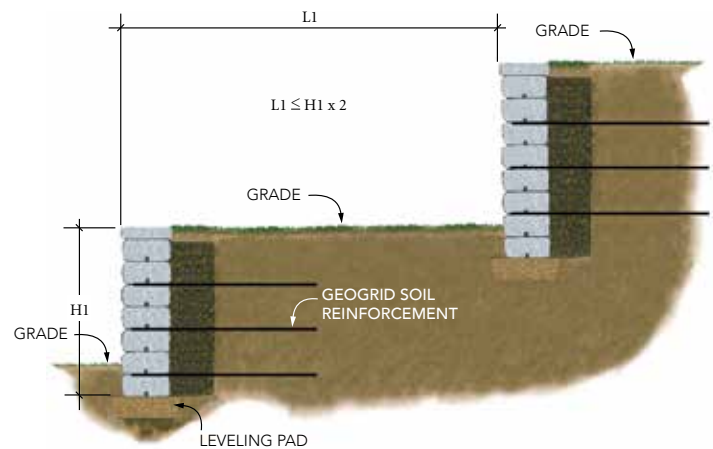

For walls where $L1 \geq H1 \times 2$, then the walls typically are analyzed separately. Walls built on slopes $\geq 3:1$ or on soft soils need to be analyzed for "global stability". Consult a qualified engineer.

Design Considerations

Design Assumptions

- Friction angle (PHI) for earth pressure calculations of geogrid reinforced walls is evaluated at 26°, 30° and 34° only. For other soil type analysis, refer to the KeyWall® PRO design software program or consult with a qualified engineer.
- Moist weight of the three soil types indicated is 120 lb./ft³ (19kN/m²).
- Sliding calculations use 6" (152mm) crushed stone leveling pad as compacted foundation material.
- All backfill materials are compacted to 95% Standard Proctor density.
- The term "vertical" is a wall built to a near vertical alignment having a slight positive setback (1°±).
- The information provided herein is for preliminary design use only. A qualified engineer should be consulted for design and analysis of structures. Keystone Retaining Wall Systems LLC assumes no liability for the improper use of this information.

Gravity Wall: Near Vertical Detail

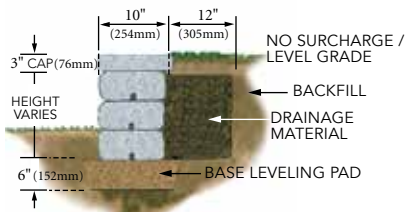

Reinforced Wall: Near Vertical Detail

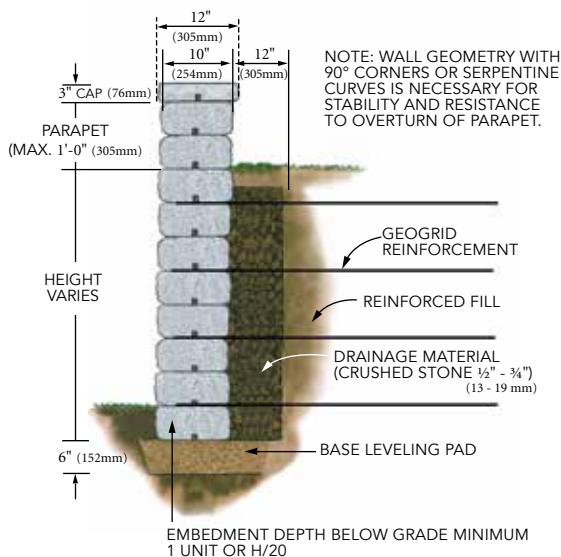

Design Notes

For low (non-structural) landscape retaining walls, Country Manor/Stonegate units can be constructed as a non-reinforced gravity wall as shown in the chart below. This chart is for retaining walls in the "near vertical" option.

GRAVITY WALLS (Maximum unreinforced wall height)				
MAXIMUM HEIGHT*	NEAR VERTICAL		9.5° +/- BATTER	
	LEVEL	3H:1V	LEVEL	3H:1V
SAND / GRAVEL PHI= 34°	2'-0" (0.6m)	1'-6" (0.45m)	3'-0" (0.9m)	2'-6" (0.75m)
SILTY SAND PHI = 30°	1'-6" (0.45m)	1'-6" (0.45m)	2'-6" (0.75m)	2'-0" (0.6m)
SILT / LEAN CLAY PHI = 26°	1'-6" (0.45m)	1'-0" (0.3m)	2'-0" (0.6m)	1'-6" (0.45m)

*Height does not include 3" (76mm) cap

Note: use pins and construction adhesive at low border/parapet walls.

Gravity Wall: Setback Detail 9.5°± Batter

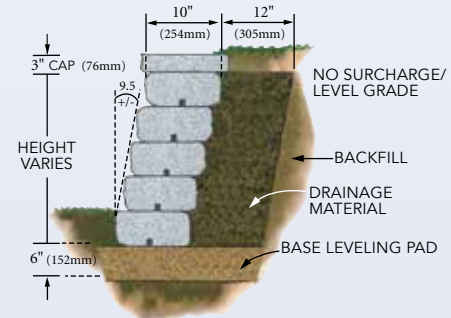

Reinforced Wall: Setback Detail 9.5°± Batter

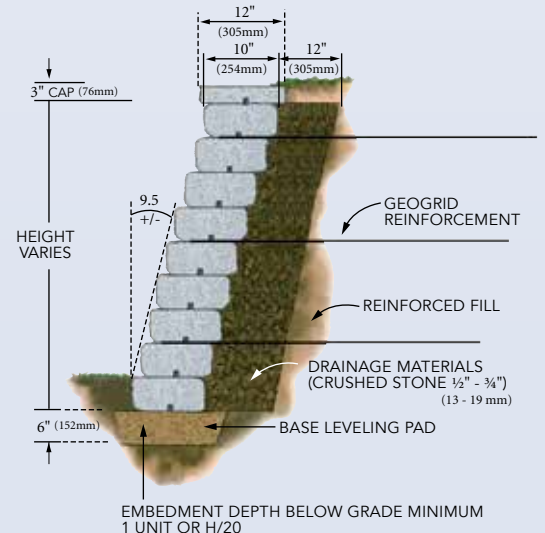

The following charts assume the use of a coated polyester geogrid with a minimum allowable design strength of:
 LTDS = 750 plf (10.9 kN/m) or Tal = 500 plf (7.3 kN/m)

Design Charts

Silt/Lean Clay: $\phi=26^\circ$, $\gamma=120$ pcf (19kN/m³)

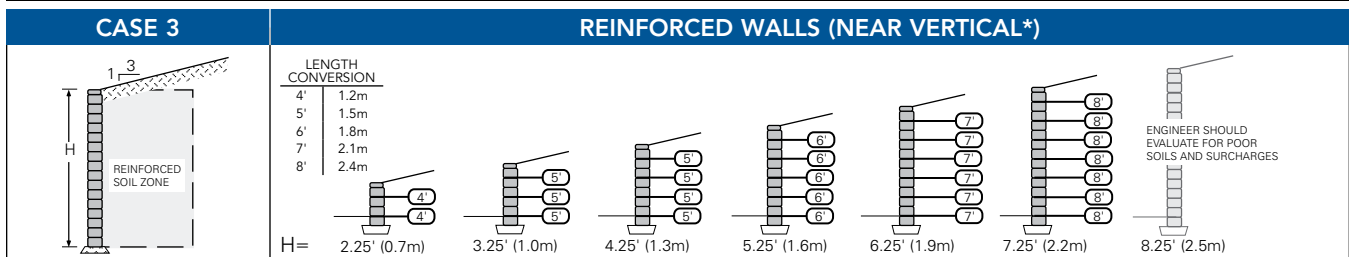
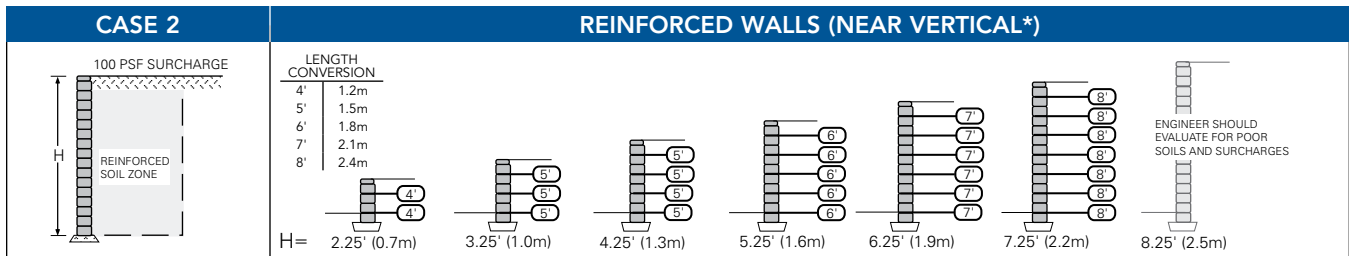
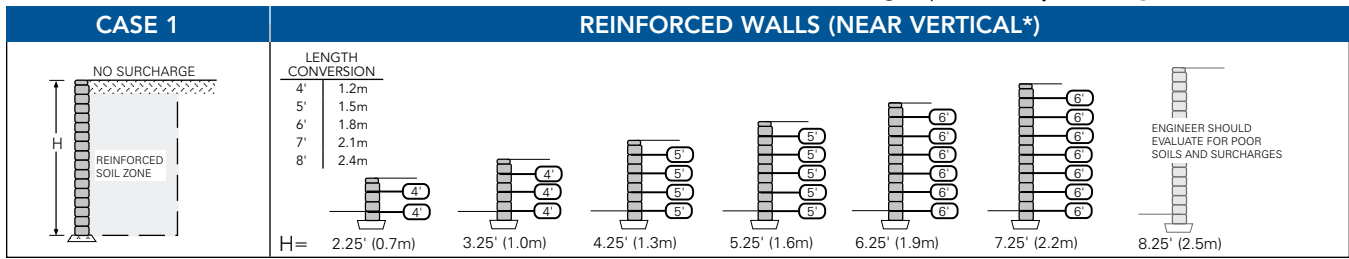

*FOR CONSTRUCTION OF NEAR VERTICAL BATTER (CENTER PIN HOLE), CONSTRUCT WITH POSITIVE BATTER BY TILTING UNITS BACK TOWARDS FILL ON LEVELING PAD. ELEVATION DROP ALONG THE 10"(254mm) WIDTH OF THE BLOCK TO BE 3/8"(10mm).

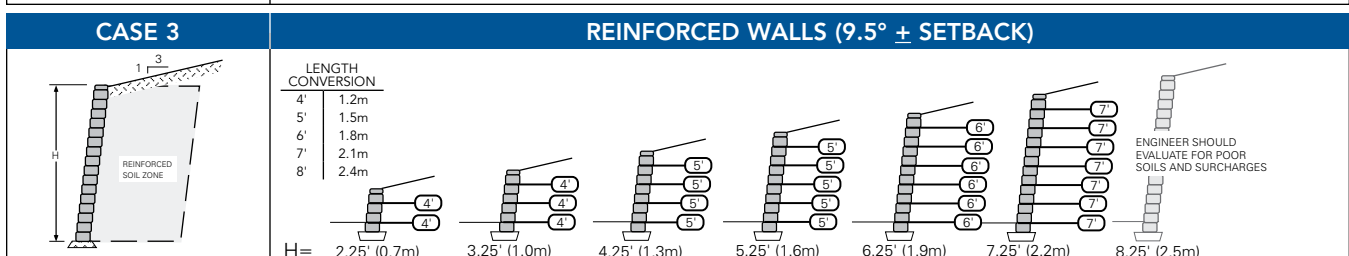
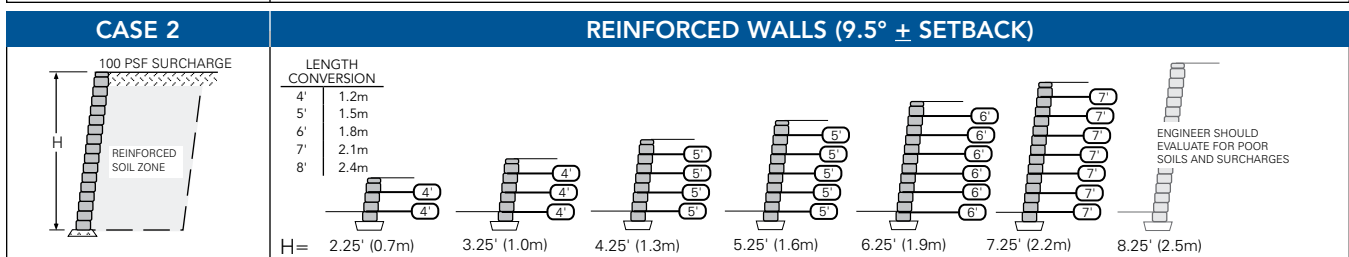
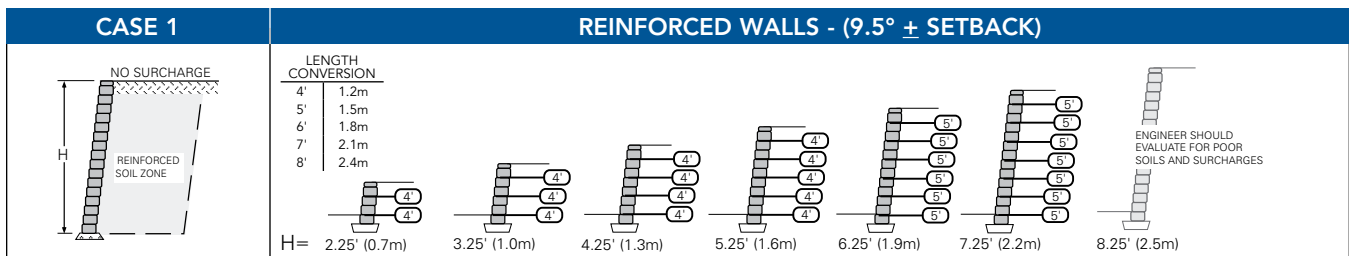

The information provided herein is for preliminary design use only. A qualified engineer should be consulted for design and analysis of structures. Keystone Retaining Wall Systems LLC assumes no liability for the improper use of this information. Information on specific geogrids is available from the geogrid manufacturer.

Design Charts

Silty Sand: $\phi=30^\circ$, $\gamma=120$ pcf (19kN/m³)

The following charts assume the use of a coated polyester geogrid with a minimum allowable design strength of:
LTDS = 750 plf (10.9 kN/m) or Tal = 500 plf (7.3 kN/m)

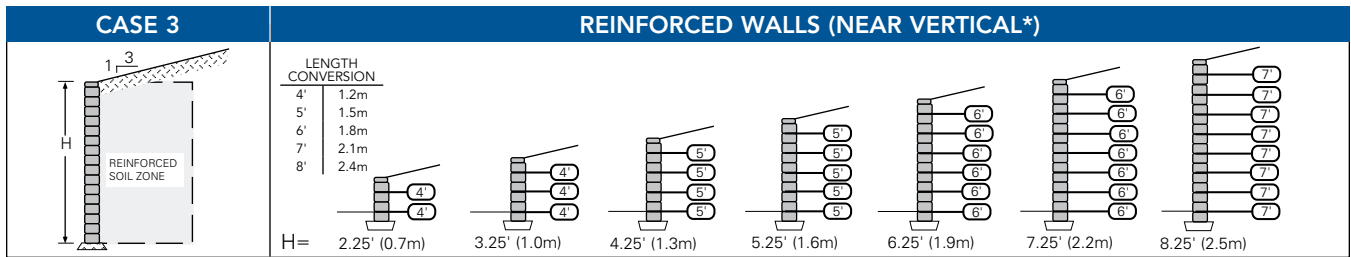
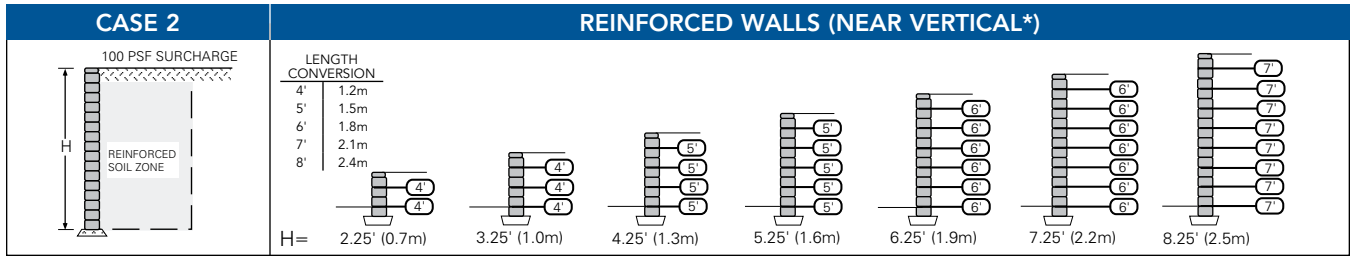
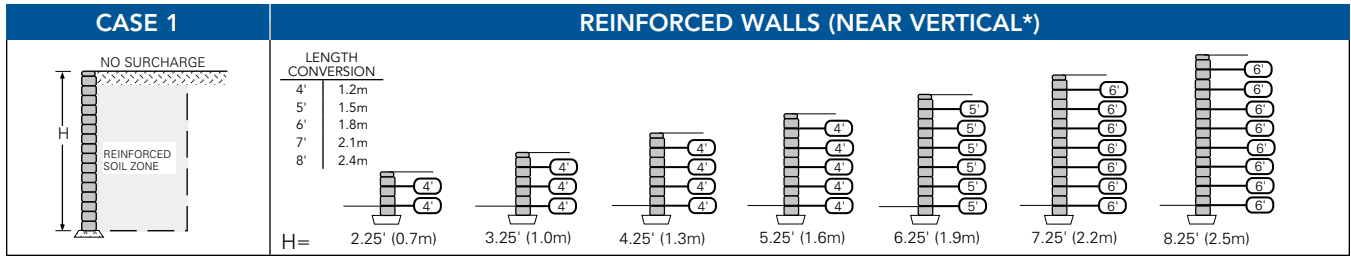

*FOR CONSTRUCTION OF NEAR VERTICAL BATTER (CENTER PIN HOLE), CONSTRUCT WITH POSITIVE BATTER BY TILTING UNITS BACK TOWARDS FILL ON LEVELING PAD. ELEVATION DROP ALONG THE 10" (254mm) WIDTH OF THE BLOCK TO BE 3/8" (10mm).

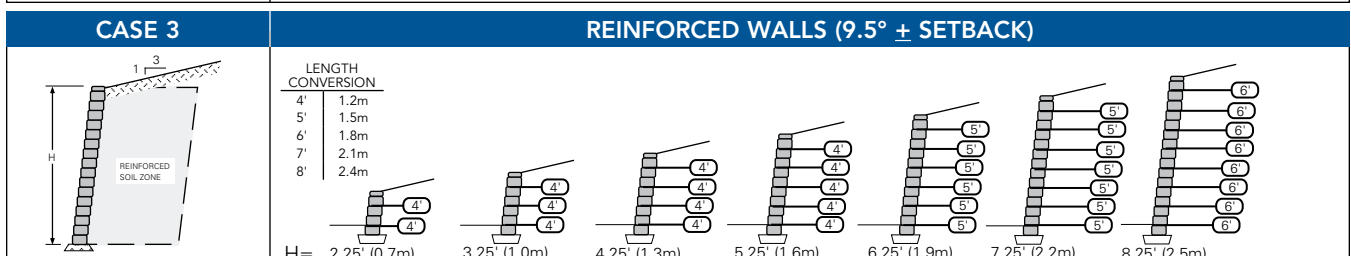
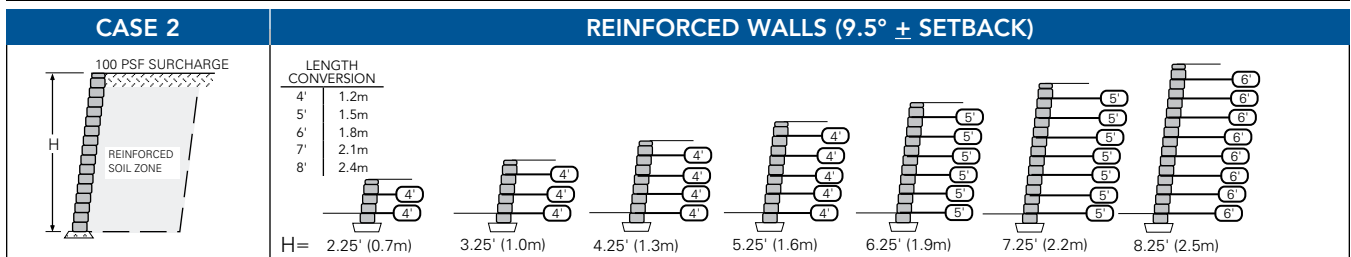
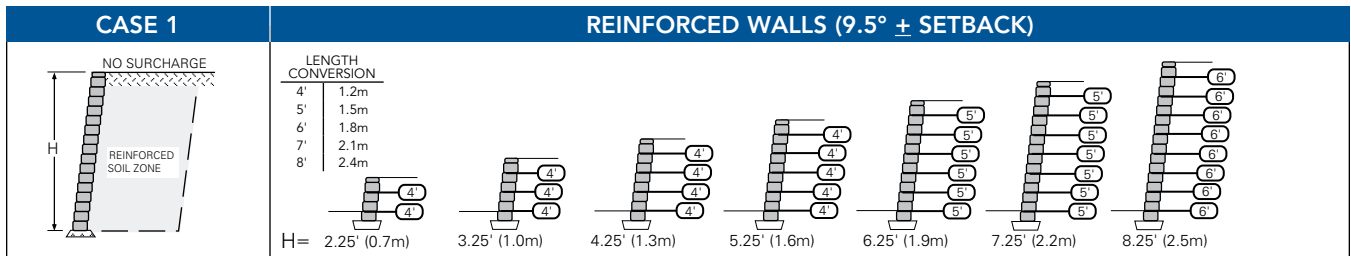

The information provided herein is for preliminary design use only. A qualified engineer should be consulted for design and analysis of structures. Keystone Retaining Wall Systems LLC assumes no liability for the improper use of this information. Information on specific geogrids is available from the geogrid manufacturer.

The following charts assume the use of a coated polyester geogrid with a minimum allowable design strength of:
 LTDS = 750 plf (10.9 kN/m) or Tal = 500 plf (7.3 kN/m)

Design Charts

Sand/Gravel: $\phi=34^\circ$, $\gamma=120$ pcf (19kN/m³)

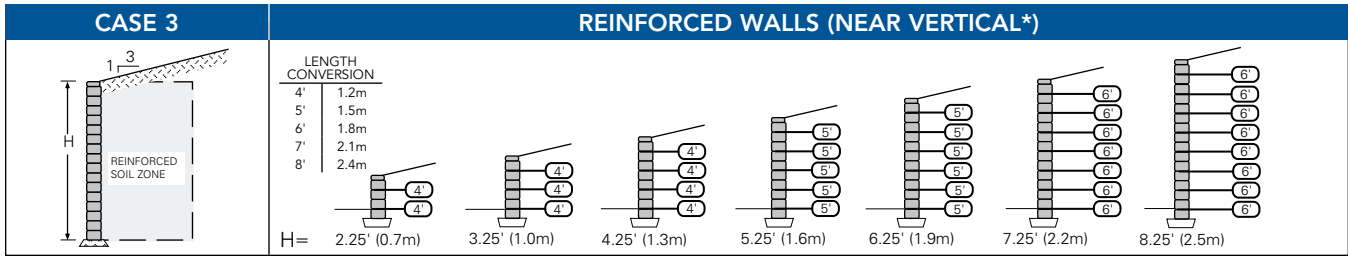
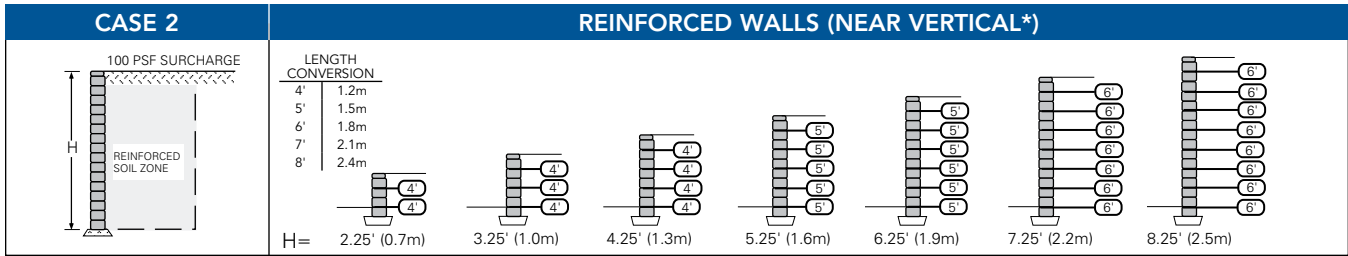
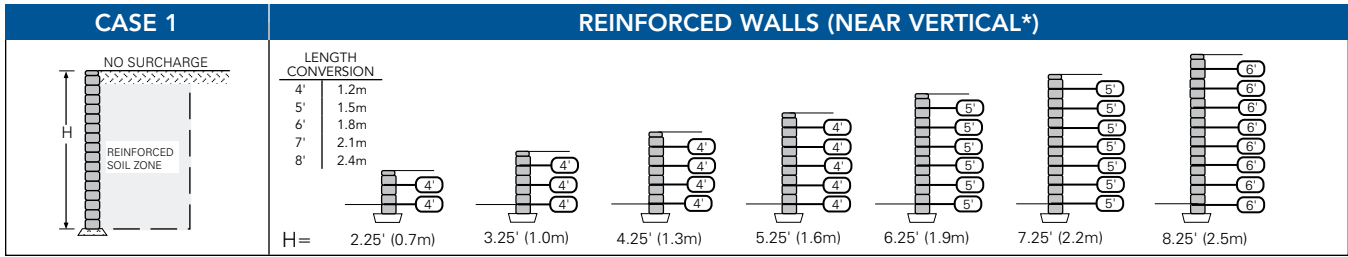

*FOR CONSTRUCTION OF NEAR VERTICAL BATTER (CENTER PIN HOLE), CONSTRUCT WITH POSITIVE BATTER BY TILTING UNITS BACK TOWARDS FILL ON LEVELING PAD. ELEVATION DROP ALONG THE 10"(254mm) WIDTH OF THE BLOCK TO BE 3/8"(10mm).

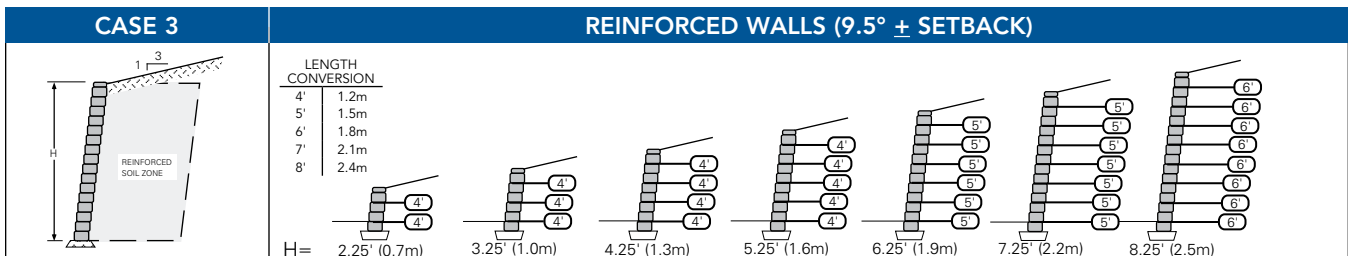
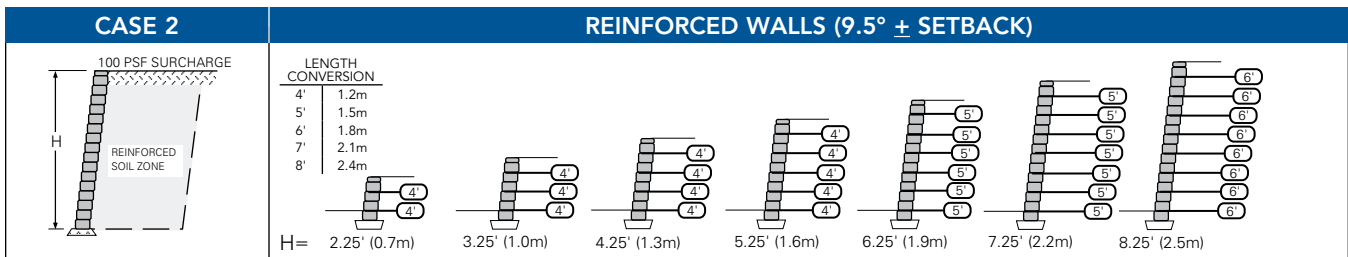
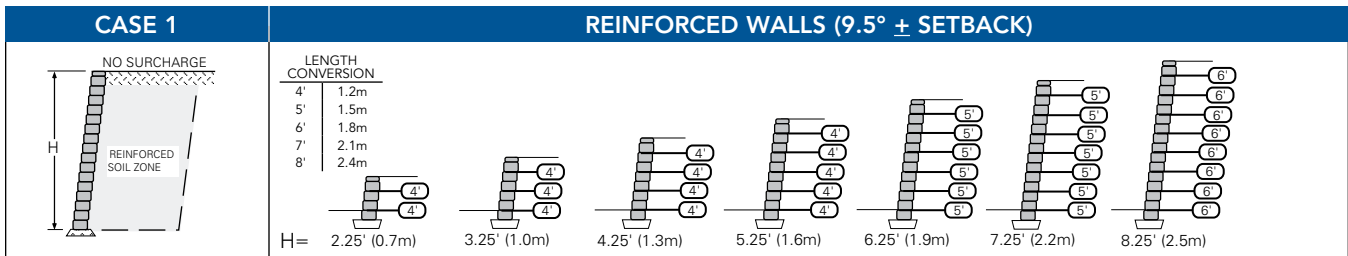

The information provided herein is for preliminary design use only. A qualified engineer should be consulted for design and analysis of structures. Keystone Retaining Wall Systems LLC assumes no liability for the improper use of this information. Information on specific geogrids is available from the geogrid manufacturer.



Country Manor®

Get Inspired!



Stonegate®



Country Manor®



Your only limit is your imagination.





Distributed By:

We reserve the right to improve our products and make changes in the specifications and design without notice. The information contained herein has been compiled by KEYSTONE and to the best of our knowledge, accurately represents the KEYSTONE product use in the applications which are illustrated. Final determination of the suitability for the use contemplated and its manner of use are the sole responsibility of the user.



Keystone Retaining Wall Systems LLC
4444 West 78th Street • Minneapolis, MN 55435
(952) 897-1040 • www.keystonewalls.com



©2020 Keystone Retaining Wall Systems LLC - Patents Pending. • CM-DC 2020

